



Published by:

**Stage Accompany B.V.**

Training & Documentation

Anodeweg 4

1627 LJ Hoom, The Netherlands

Copyright © 1989 by Stage Accompany B.V.

All rights reserved. No part of this manual may be reproduced or transmitted in any form or by any means, electronic or mechanical, without written permission from Stage Accompany, except for the inclusion of brief quotations in a review.

First Printing, September 1989

Printed in The Netherlands

This manual is designed to provide information about the PPA 1200. Every effort has been made to make this manual complete and as accurate as possible. But no warranty of suitability, purpose, or fitness is implied. The information is provided on an "as-is" basis. Stage Accompany shall have neither liability nor responsibility to any person or entity with respect to any loss or damages in connection with or arising from the information contained in this manual.

IBM is a registered trademark of International Business Machines Corporation.



**PPA 1200 USER MANUAL**

# **Stage Accompany PPA 1200**

Programmable Power Amplifier

User Manual

*The Professionals  
For Professionals!*



## PPA 1200 USER MANUAL

Published by:

**Stage Accompany B.V.**

Training & Documentation

Anodeweg 4

1627 LJ Hoorn, The Netherlands

Copyright © 1989 by Stage Accompany B.V.

All rights reserved. No part of this manual may be reproduced or transmitted in any form or by any means, electronic or mechanical, without written permission from Stage Accompany, except for the inclusion of brief quotations in a review.

First Printing, September 1989

Printed in The Netherlands

This manual is designed to provide information about the PPA 1200. Every effort has been made to make this manual complete and as accurate as possible. But no warranty of suitability, purpose, or fitness is implied. The information is provided on an "as-is" basis. Stage Accompany shall have neither liability nor responsibility to any person or entity with respect to any loss or damages in connection with or arising from the information contained in this manual.

IBM is a registered trademark of International Business Machines Corporation.

---

*The Professionals  
For Professionals !*



## PPA 1200 USER MANUAL

<b>Table of Contents</b>	■
<b>Quick Introduction to the PPA 1200</b>	■
<b>Introduction</b>	■
<b>Connections</b>	■
<b>Operation</b>	■
<b>Indicators</b>	■
<b>Recommendations for optimum Use of the PPA 1200</b>	■
<b>Technical Specifications</b>	■
<b>Trouble Shooting</b>	■



# Table Of Contents

<b>1</b>	<b>Quick Introduction to the PPA 1200.</b>	<b>1-1</b>
<b>2</b>	<b>Introduction</b>	<b>2-1</b>
<b>3</b>	<b>Connection of the PPA 1200.</b>	<b>3-1</b>
3-1	Mains Power.	3-1
3.2	Audio Connections	3-8
3.3	Loudspeaker Connections	3-8
3.4	SAnet Connections.	3-16
<b>4</b>	<b>Operation</b>	<b>4-1</b>
4.1	Readout Select.	4-1
4.2	Level.	4-1
4.3	Maximum Power and Active Crossover Presets.	4-1
4.4	Power Amp On Delay.	4-3
4.5	Channel Mode	4-3
4.6	System Ground Lift.	4-4
4.7	SAnet Ground Lift.	4-5
4.8	Input Ground Lift.	4-5
4.9	System Lock/Unlock.	4-5
4.10	Bridge Mode.	4-6
4.11	Software Version	4-6
4.12	ID Code	4-6
4.13	Signal Present Time	4-7
4.14	Power Amplifier On Time	4-8
4.15	Activating the “boot” mode	4-8
<b>5</b>	<b>Indicators</b>	<b>5-1</b>
5.1	Input Signal Present.	5-1
5.2	Clipping of the Amplifier	5-1
5.3	Power Limiting	5-1
5.4	DC Protection of the Amplifier	5-2
5.5	Overheated Amplifier	5-2
5.6	High Power Fuse Blown	5-2



# PPA 1200 USER MANUAL

6	Recommendations for Optimum Use.....	6-1
7	PPA 1200 Specifications.....	7-1
8	Security Function .....	8-1
8.1	Resetting the System Lock and Lock Code .....	8-1

TABLE OF CONTENTS

*The Professionals  
For Professionals !*



## 1 Quick Introduction to the PPA 1200

If you have to start using the PPA 1200 straight away and do not have time to read the complete manual, make sure that you at least read the following:

- Ensure that you have a reliable, well earthed power source. The required current for the PPA can be found in the table in paragraph 3.1.
- Connect the PPA to your signal sources via the <AUDIO IN> inputs. Connect this PPA to other units via the <AUDIO OUT> outputs using short signal leads. Connect your single signal source to the channel 1 input if you use the PPA in active crossover mode or bridge mode.

**IMPORTANT:** Due to the fact that the low-frequency loudspeaker of the Blue Box has an polarity opposite to that of the PPA/(all other SA loudspeakers) combination, the Blue Box has to be switched to inverted phase or cross cables between PPAs and Blue Boxes have to be used!

- If computer control is desired, connect all PPAs with each other via <SANET IN> and <SANET OUT>.
- Switch the PPA on using the <POWER ON/OFF> switch.

If you want to use the PPA in active crossover mode, use the <READOUT SELECT> key to display the <MAXIMUM POWER>. The LED next to the word "Maximum power" will light up; the displays register "900" (this is only true the first time the PPA is switched on or after a "reset": normally the last set values will be read from the memory).

- Press the <DOWN> key of channel 1 and keep it depressed. The value in the display decreases from 900 to 30. Below 30 is a sequence of Stage Accompany loudspeaker systems. Select the desired system using the channel 1 <UP> or <DOWN> key. An overview of the various active crossover presets can be found in paragraph 4.3.

If you want to use the PPA in bridge mode, press the <BRIDGE MODE> key and keep it depressed for at least 1 second until the channel 2 display and indications are disabled and the <BRIDGE MODE> LED lights up. The bridged amplifier can now be controlled using the channel 1 controls.

- Switch both channels of the PPA from <STAND BY> (green LED lit) to <POWER AMP ON> (red LED lit) using the <CHANNEL MODE> keys.
- Use the <READOUT SELECT> key to display the <LEVEL>. The LED next to the word "Level" will light up; the displays register "OFF" (this is only true the first time the PPA is switched on or after a "reset": normally the last set values will be read from the memory).



If the PPA is in active crossover mode, you do not have to adjust both low and high levels. They are automatically set with the correct proportion when you select a loudspeaker system. In the other modes, press both <UP> keys of channel 1 and channel 2 and keep them depressed. The values in the displays increase from OFF, via -59 dB to 0 dB (completely open). However, you may adjust the level of both amplifiers independently.

- Any earth hum that may be present may be cured with the <INPUT GROUND> keys, the <SYSTEM GROUND> key, or (if connected) the <SA-NET GROUND> key.
- The use of the <SYSTEM LOCK> key is not directly necessary for the function of the PPA. For further information, see paragraph 4.9.

The PPA 1200 is now ready for use.



## 2 Introduction

The Stage Accompany PPA 1200 is a dual channel high power microcomputer controlled amplifier and comprises the following components:

- Balanced input stages.
- High and low pass filters per channel with 6-24 dB/octave slopes.
- Two amplifiers which each deliver 350 Watts RMS into 8 Ohms, 600 Watts RMS into 4 Ohms, and 900 Watts RMS into 2 Ohms.
- Microcomputer for control and protection of the unit.
- High speed computer interface (SAnet) for control via an IBM® (compatible) Personal Computer.

Individual power supplies provide for an excellent channel separation and availability of the maximum power at all times.

The functioning of the PPA is controlled and monitored by the built-in microcomputer. Via the SAnet interface, the system can be controlled remotely by the Stage Accompany PC-AT or any IBM (compatible) PC-AT. A maximum of 250 PPA 1200s can be controlled at distances of up to 500 meters.

Note: The PPA performs excellently without a PC and/or interconnection via SAnet. The SAnet interface is a standard provision that enables groupwise operation, but does not need to be used.

The audio input and output are connected internally without electronics. This is done to prevent any loss of quality. With an input impedance of 24 kohms, it is possible to connect a maximum of 30 PPAs with each other. If more than 30 units need to be connected to each other, a separate signal driver must be used.

The PPA is protected against the connection of speaker impedances less than 2 Ohms or even shortcircuiting of the output. The output current is limited but the amplifier keeps working.



The PPA has a number of unique features, including:

- AEC, Auto Energy Control.
- DDC, Dynamic Damping Control.
- Built-in SA loudspeaker presets with crossover and protection.
- Temperature, peak and average output power readout.
- SAnet interface.

## AEC

Auto Energy Control is a two-fold protection against clipping and overload at average power and at peak power, which maintains the complete dynamic range of the signal. The microprocessor continuously measures the output power of the amplifier and monitors both the average power and peak power. All levels are compared with the pre- and user-programmed values of the AEC. As soon as an overload is detected, the volume is reduced in proportion to the amount of overloading.

As soon as the cause of the overload has disappeared, the volume is gradually returned to its original value. Attack and release times are independent of the type of overload and have been chosen in such a way that a virtually inaudible operation is guaranteed.

## DDC

Dynamic Damping Control is a special way of measuring the cone movement of a loudspeaker. The voltage induced in the voicecoil is sensed and fed back to the amplifier's feedback circuit. Hence, a virtually infinite damping is achieved, which results in an exceptionally tight sound reproduction.

## Built-in SA-loudspeaker presets with crossover and protection

For optimum performance the PPA can be used in combination with a number of Stage Accompany two and three way cabinets to form an active loudspeaker system. For this purpose, the PPA has a built-in crossover and a number of so called crossover presets which are programmed with predefined low and high levels and optimum protection parameters. The crossover is always activated in preset mode in which channel 1 can be a low or midfrequency amplifier and channel 2 a low or high frequency amplifier.

## Temperature, peak and average output power readout

True peak and average output power are measured and displayed in Watts for each channel. Furthermore the temperature of the power amplifier output semiconductors is displayed per channel in degrees Celcius (°C).

*The Professionals  
For Professionals !*



## **SAnet Interface**

The SAnet Interface is a computer interface developed by Stage Accompany that can be used for monitoring and control of automated sound systems. Apparatus equipped with an SAnet Interface (such as the Blue Box, PPA 1200 Programmable Amplifier and PPE 2410 Programmable Parametric Equalizer) can be connected to a Personal Computer, allowing remote monitoring and control. All parameters of the individual units can be programmed and monitored from the PC. Furthermore, the apparatus (such as PPAs) can be grouped as desired and then controlled groupwise. The maximum communication distance, using the correct type of cable, is 500 meters.

SAnet is a genuine communication system: data transfer occurs bi-directionally along the same line. This is in contrast to (for example) MIDI. MIDI has separate in, out and thru provisions and cabling, restricting communication to only one direction. The transmission speed of MIDI is approximately 32 kB/s, that of SAnet is 375 kB/s, more than 10 times as fast!

SAnet and MIDI are not compatible!

For the application of SAnet, see paragraph 3.4 of this manual.

### 3 Connection of the PPA 1200

Only three connections need to be made; mains power, audio input signals, and loudspeaker leads. An SAnet connection is not necessary for normal (stand alone) functioning of the PPA.

#### 3.1 Mains Power

The PPA is set for 220 V / 50 Hz unless otherwise stated at the back of the amplifier. Always ensure that you use a correctly grounded power supply. If more than one PPA is to be used, it is advisable to connect each one separately to the nearest mains supply instead of connecting several PPAs using an adaptor block (see figure 3-1).

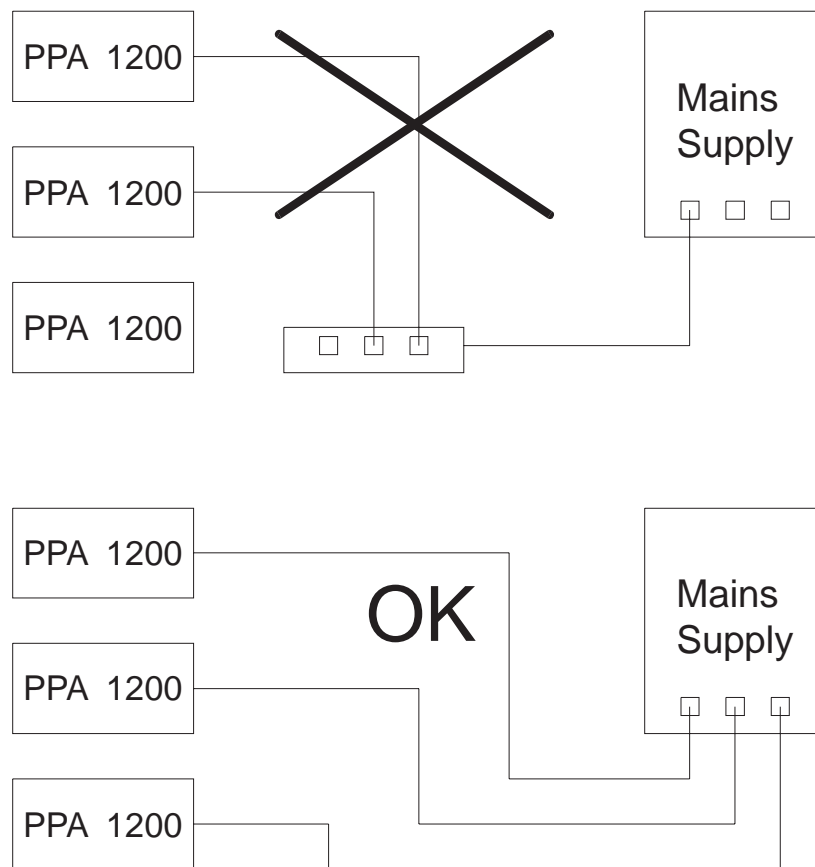

Figure 3-1. PPA 1200 connections to the mains supply.



This prevents unnecessary power loss in the cabling. If circumstances do not allow this, it is advisable to connect the adaptor block directly to the power supply using a short cable and then connect the individual PPAs to it using longer leads. Although this method is not ideal, it does limit power loss as much as possible.

Ultimately, it is possible to place the adaptor block near a PPA, but if a great deal of power is required from the unit, the final current provided is far from optimum: loss of current leads to unrecoverable loss of sound pressure.

**WARNING:** Always disconnect the PPA from the power supply before operating the fuse holders! Replace a blown fuse only with a new one of the same value!

**Current Table**

Below, the current consumption of the PPA is tabulated for various mains voltages. The power consumption shown applies to full output power (2 x 900 Watts into 2 Ohms). However, the power consumption will be generally less than the shown one, specially when your speaker system has an impedance of 4 or 8 Ohms.

No. PPA's	Power Required (VA)	Mains Voltage (V)							
		100	110	120	200	220	230	240	
		Current Consumption (A)							
1	3520	35	32	29	17	16	15	14	
2	7040	70	64	58	35	32	30	29	
3	10560	105	96	88	52	48	45	44	
4	14080	140	128	117	70	64	61	58	
5	17600	176	160	146	88	80	76	73	
6	21120	211	192	176	105	96	91	88	
7	24640	246	224	205	123	112	107	102	
8	28160	281	256	234	140	128	122	117	
9	31680	316	288	264	158	144	137	132	
10	35200	352	320	293	176	160	153	146	

The stability of the mains voltage is very important because the PPA contains a microcomputer. The mains voltage may NOT deviate more than 20% of the nominal mains voltage! To avoid damage to critical parts, the PPA shuts itself off if the mains voltage drops below 80% of its nominal value.

*The Professionals  
For Professionals !*

The proportional mains voltage cable loss may not exceed 10%. The following formula may be used to calculate the maximum mains cable length in meters (where \* means multiply):

$$\text{Maximum Length (ML)} = \frac{G * V * V}{2400 * N}$$

The three input variables are:

- N - number of PPAs supplied through the cable
- G - cable gauge in square millimeters
- V - mains voltage in Volts

This means that the cable length is proportional to the cable gauge and the square of the mains voltage, while it is inversely proportional to the number of PPAs supplied through the cable. An example will explain the use of this formula:

- N = 4 (4 PPAs connected)
- G = 2.5 (cable gauge is 2.5 square millimeters)
- V = 220 (mains voltage is 220 Volts)

$$\text{Maximum Length (ML)} = \frac{G * V * V}{2400 * n} = \frac{121000}{9600} = 12.6$$

It follows that the maximum cable length is 12.6 meters.

On the next pages, per mains voltage a table is shown with the maximum mains cable length in meters, given the cable gauge in square millimeters and the number of PPAs supplied through the cable.

**<Warning !>**

In spite of the surge protection, the current peak at power-up can be up to three times the magnitude of the nominal required current! Therefore, never switch on multiple PPAs simultaneously. Use the <POWER AMP ON DELAY> feature (see paragraph 4-4).

*The Professionals  
For Professionals !*

Do not switch the PPA <CHANNEL MODES> on/off very frequently within a short time. This causes the surge protection (NTC) to warm up, decreasing its resistance so that the power-up peak current increases!

100V		Cable Gauge (mm <sup>2</sup> )					
		1.5	2.5	4.0	6.0	10.0	16.0
No. of PPAs	1	6	10	17	25	42	67
	2	3	5	8	13	21	33
	3	2	3	6	8	14	22
	4	2	3	4	6	10	17
	5	1	2	3	5	8	13
	6	1	2	2	4	7	11
	7	1	1	2	4	6	10
	8	1	1	2	3	5	8
	9	1	1	2	3	5	7
	10	1	1	2	3	4	7

**Figure 3-2.** Maximum cable length as a function of the cable gauge and the number of PPA's supplied through the cable.

110V		Cable Gauge (mm <sup>2</sup> )					
		1.5	2.5	4.0	6.0	10.0	16.0
No. of PPAs	1	8	13	20	30	50	81
	2	4	6	10	15	25	40
	3	3	4	7	10	17	27
	4	2	3	5	8	13	20
	5	2	3	4	6	10	16
	6	1	2	3	5	8	13
	7	1	2	3	4	7	12
	8	1	2	3	4	6	10
	9	1	1	2	3	6	9
	10	1	1	2	3	5	8

**Figure 3-3.** Maximum cable length as a function of the cable gauge and the number of PPA's supplied through the cable.

120V		Cable Gauge (mm <sup>2</sup> )					
		1.5	2.5	4.0	6.0	10.0	16.0
No. of PPAs	1	9	15	24	36	60	96
	2	5	8	12	18	30	48
	3	3	5	8	12	20	32
	4	2	4	6	9	15	24
	5	2	3	5	7	12	19
	6	2	3	4	6	10	16
	7	1	2	3	5	9	14
	8	1	2	3	5	8	12
	9	1	2	3	4	7	11
	10	1	2	2	4	6	10

**Figure 3-4.** Maximum cable length as a function of the cable gauge and the number of PPA's supplied through the cable.

200V		Cable Gauge (mm <sup>2</sup> )					
		1.5	2.5	4.0	6.0	10.0	16.0
No. of PPAs	1	25	42	67	100	167	267
	2	13	21	33	50	83	133
	3	8	14	22	33	56	89
	4	6	10	17	25	42	67
	5	5	8	13	20	33	53
	6	4	7	11	17	28	45
	7	4	6	10	14	24	38
	8	3	5	8	13	21	33
	9	3	5	7	11	19	30
	10	3	4	7	10	17	27

**Figure 3-5.** Maximum cable length as a function of the cable gauge and the number of PPA's supplied through the cable.

220V		Cable Gauge (mm <sup>2</sup> )					
		1.5	2.5	4.0	6.0	10.0	16.0
No. of PPAs	1	30	50	81	121	202	323
	2	15	25	40	61	101	161
	3	10	17	27	40	67	108
	4	8	13	20	30	50	81
	5	6	10	16	24	40	65
	6	5	8	13	20	34	54
	7	4	7	12	17	29	46
	8	4	6	10	15	25	40
	9	3	6	9	13	22	36
	10	3	5	8	12	20	32

**Figure 3-6.** Maximum cable length as a function of the cable gauge and the number of PPA's supplied through the cable.

230V		Cable Gauge (mm <sup>2</sup> )					
		1.5	2.5	4.0	6.0	10.0	16.0
No. of PPAs	1	33	55	88	132	220	353
	2	17	28	44	66	110	176
	3	11	18	29	44	73	118
	4	8	14	22	33	55	88
	5	7	11	18	27	44	71
	6	6	9	15	22	37	59
	7	5	8	13	19	32	51
	8	4	7	11	17	28	44
	9	4	6	10	15	25	39
	10	3	6	9	13	22	35

**Figure 3-7.** Maximum cable length as a function of the cable gauge and the number of PPA's supplied through the cable.

240V		Cable Gauge (mm <sup>2</sup> )					
		1.5	2.5	4.0	6.0	10.0	16.0
No. of PPAs	1	36	60	96	144	240	384
	2	18	30	48	72	120	192
	3	12	20	32	48	80	128
	4	9	15	24	36	60	96
	5	7	12	19	29	48	77
	6	6	10	16	24	40	64
	7	5	9	14	21	34	55
	8	5	8	12	18	30	48
	9	4	7	11	16	27	43
	10	4	6	10	14	24	39

**Figure 3-8.** Maximum cable length as a function of the cable gauge and the number of PPA's supplied through the cable.

### 3.2 Audio Connections

The XLR connectors (audio in and audio link) of the PPA are wired as follows:

Pin 1 = ground

Pin 2 = normal phase (+ or "hot")

Pin 3 = inverted phase (- or "cold")

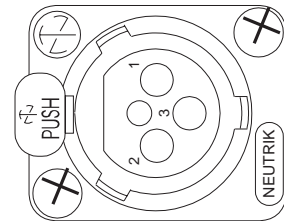

Always use high quality XLR connectors and screened signal cables. Using the output connectors, up to 30 PPAs can be linked without problem. If more than 30 PPAs need to be interconnected, a separate signal driver should be used.

### 3.3 Loudspeaker Connections

Due to the DDC feature, the PPA has 4 output terminals per channel instead of 2. The speakon connector is wired as follows:

Pin 1+ = signal (+ or "hot")

Pin 1- = ground (- or "cold")

Pin 2+ = DDC-signal (DDC+ or "DDC hot")

Pin 2- = DDC-ground (DDC- or "DDC cold")

For optimum performance, the amplifier to loudspeaker connections should be made as shown in figure 3-9.

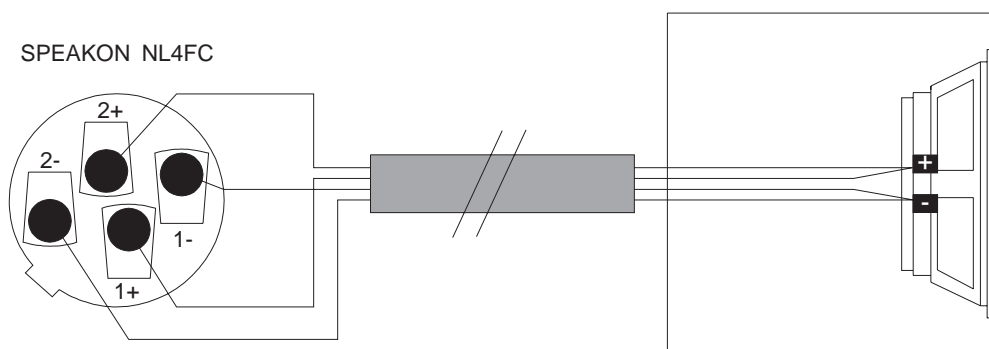
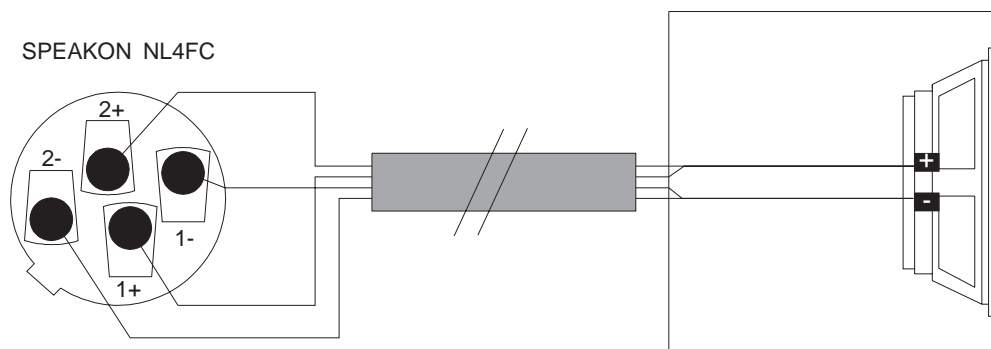

Figure 3-9. PPA 1200 with 4-terminal loudspeaker connection.

*The Professionals  
For Professionals !*

The signal and DDC-signal (Dynamic Damping Control) terminals are linked together at the loudspeaker hot terminal. The ground and DDC-ground terminals are linked at the loudspeaker cold terminal. A maximum damping is obtained with these connections. If your speaker system is not prepared for a four terminal connection, link the DDC and the signal/ground leads at the input of the enclosure (see figure 3-10).



**Figure 3-10.** PPA 1200 with 2-terminal loudspeaker connection.

If you don't want to use the DDC feature at all, the DDC and the signal/ground leads should be linked at the amplifier output in the speakon connector (see figure 3-11). The DDC terminals can also be left unconnected but the performance will be less.

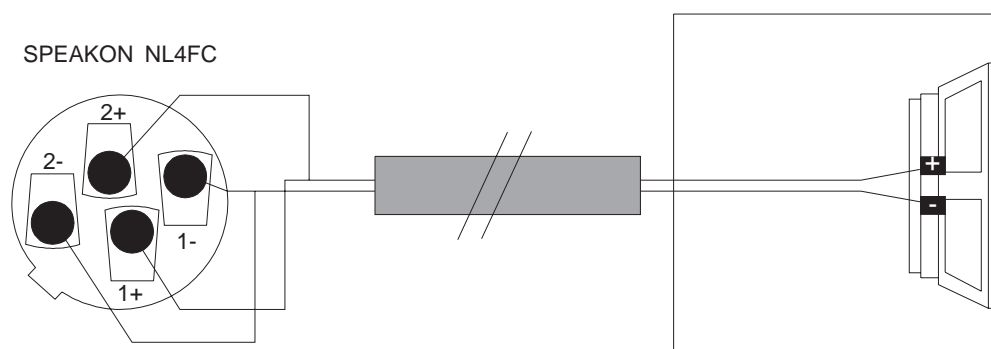

**Figure 3-11.** PPA 1200 with 2-terminal loudspeaker connection.

**WARNING:** Never shortcircuit the DDC terminals, and never connect the signal terminal to the DDC-ground terminal or vice versa (see figure 3-12 on the next page). Since you are disabling the amplifier's feedback network, signal gain will be almost infinite. The smallest input signal will result in full power output with the possibility of square waves damaging your loudspeakers!

Therefore, check your cables regularly. We also advice you to use special Stage Accompany 4-wire loudspeaker cable: 2 x 3.0 square millimeters and 2 x 0.75 square millimeters.

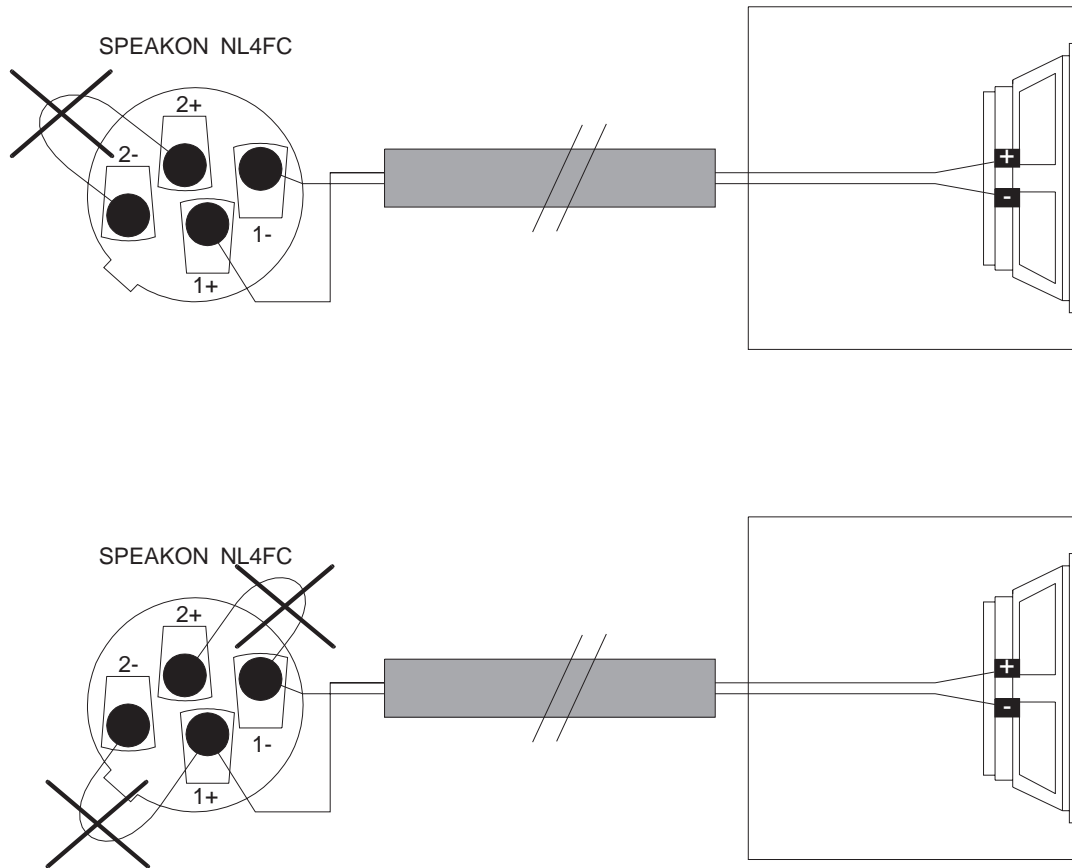

**Figure 3-12.** Dangerous PPA 1200 output connections.

When more speakers are going to be connected to one amplifier, split the output and DDC leads as soon as possible behind the output terminals (see figure 3-13 on this and next page).

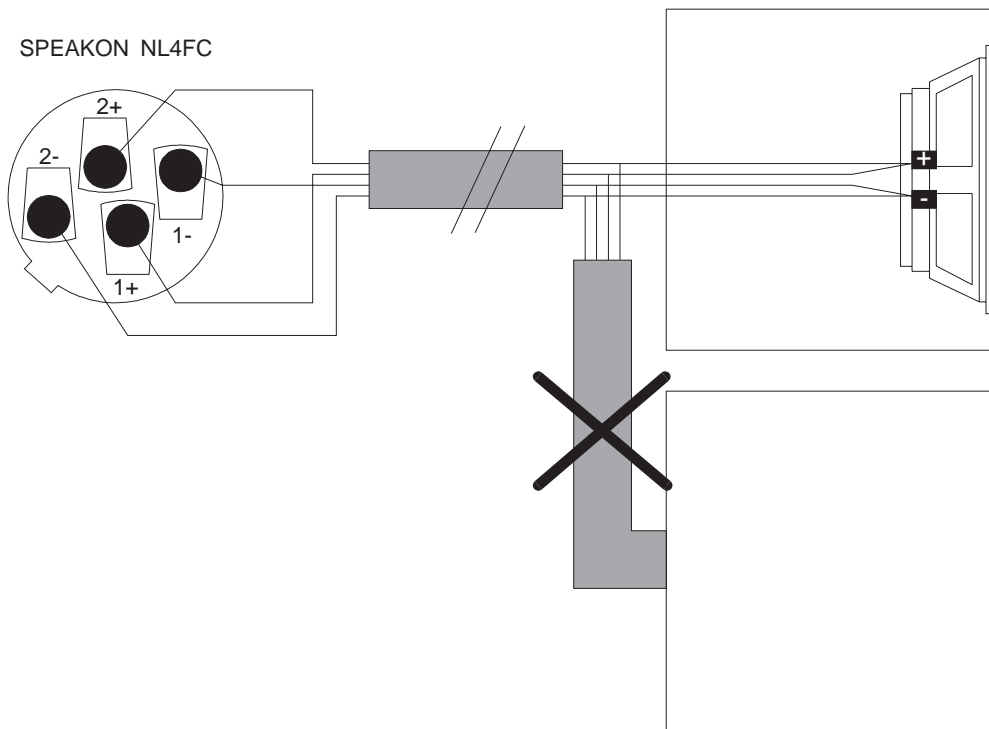
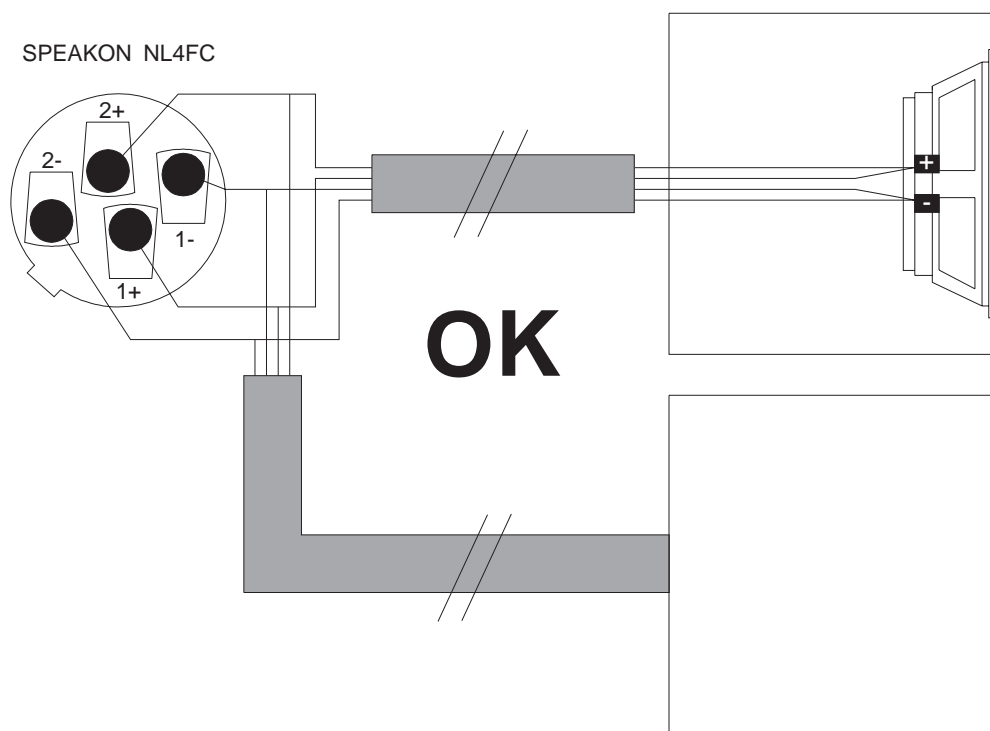

Figure 3-13. PPA 1200 connections to several enclosures.



The amplifier can cope with any load of 2 Ohms or higher. This means that you may connect a maximum of two 4 Ohms, four 8 Ohms, or eight 16 Ohms loudspeakers per channel in parallel. Linking the loudspeakers from one enclosure to another has two major disadvantages:

1. The loudspeaker cable from the amplifier to the first enclosure conducts the current for all enclosures, which means extra losses.
2. The DDC only works for the first enclosure.

Splitting the leads at the amplifier output terminals solves these problems (see figure 3-13). The DDC system corrects the performance loss due to connectors, loudspeaker cables and so on. However, it cannot prevent loss of power. So only use cables of minimal 2 x 1.5 square millimeters or more for the loudspeaker leads and 2 x 0.75 square millimeters for the DDC leads.

For bridge mode operation, the correct connections are shown in figure 3-14. For the connection of the signal terminals, you may use the options previously described according 2 channel operation. However, all the ground terminals ALWAYS have to be shortcircuited for proper bridge mode operation.

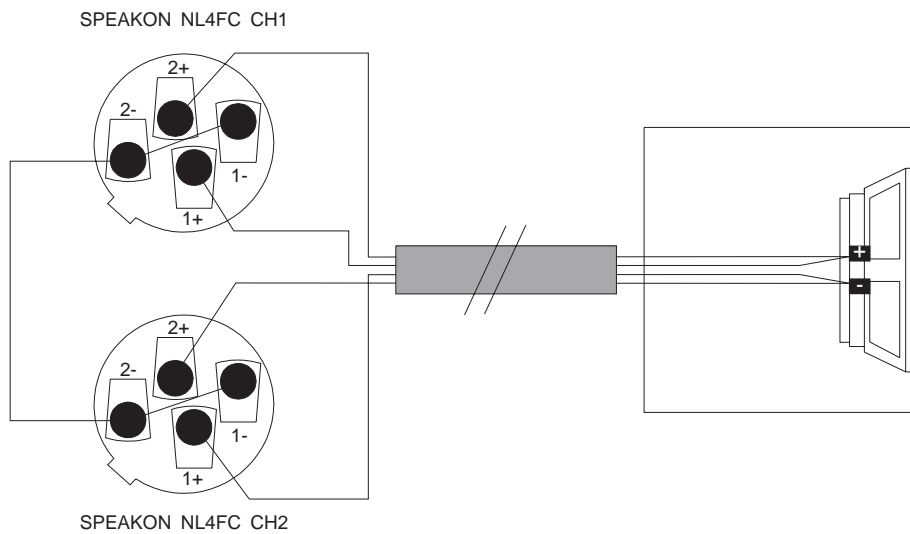

Figure 3-14. PPA 1200 bridge mode to loudspeaker connections.

An indication of the proportional loudspeaker cable power loss can be calculated using the following formula (where \* means multiply):

$$\text{Proportional Power Loss} = \frac{100}{2 + \frac{0.034 * L}{G * R} + \frac{29.4 * G * R}{L}}$$

where the variables represent:

- L - cable length in meters
- G - cable gauge in square millimeters
- R - DC resistance of the loudspeaker(s) in Ohms

This formula is based on the DC resistance in stead of the complex impedance of the loudspeaker(s). However, the approximation can be used to get a good impression of the loudspeaker cable power loss. Per loudspeaker impedance a table is shown in figures 3-15 to 3-18 with the proportional power loss, given the loudspeaker cable gauge in square millimeters and the cable length in meters.

16 Ohms		Cable Gauge (mm <sup>2</sup> )						
		1.5	2.5	3.0	4.0	6.0	10.0	16.0
Cable Length (m)	10	1.4	0.8	0.7	0.5	0.4	0.2	0.1
	20	2.7	1.6	1.4	1.0	0.7	0.4	0.3
	30	3.9	2.4	2.0	1.5	1.0	0.6	0.4
	40	5.1	3.2	2.7	2.0	1.4	0.8	0.5
	50	6.2	3.9	3.3	2.5	1.7	1.0	0.7
	100	10.9	7.2	6.2	4.8	3.3	2.0	1.3

**Figure 3-15.** Proportional power loss as a function of loudspeaker cable gauge and cable length.

8 Ohms		Cable Gauge (mm <sup>2</sup> )						
		1.5	2.5	3.0	4.0	6.0	10.0	16.0
Cable Length (m)	10	2.7	1.6	1.4	1.0	0.7	0.4	0.3
	20	5.1	3.2	2.7	2.0	1.4	0.8	0.5
	30	7.2	4.6	3.9	3.0	2.0	1.2	0.8
	40	9.1	6.0	5.1	3.9	2.7	1.6	1.0
	50	10.9	7.2	6.2	4.8	3.3	2.0	1.3
	100	17.2	12.4	10.9	8.7	6.2	3.9	2.5

**Figure 3-16.** Proportional power loss as a function of loudspeaker cable gauge and cable length.

4 Ohms		Cable Gauge (mm <sup>2</sup> )						
		1.5	2.5	3.0	4.0	6.0	10.0	16.0
Cable Length (m)	10	5.1	3.2	2.7	2.0	1.4	0.8	0.5
	20	9.1	6.0	5.1	3.9	2.7	1.6	1.0
	30	12.4	8.4	7.2	5.6	3.9	2.4	1.5
	40	15.1	10.5	9.1	7.2	5.1	3.2	2.0
	50	17.2	12.4	10.9	8.7	6.2	3.9	2.5
	100	23.1	18.9	17.2	14.5	10.9	7.2	4.8

**Figure 3-17.** Proportional power loss as a function of loudspeaker cable gauge and cable length.

2 Ohms		Cable Gauge (mm <sup>2</sup> )						
		1.5	2.5	3.0	4.0	6.0	10.0	16.0
Cable Length (m)	10	9.1	6.0	5.1	3.9	2.7	1.6	1.0
	20	15.1	10.5	9.1	7.2	5.1	3.2	2.0
	30	18.9	14.1	12.4	10.0	7.2	4.6	3.0
	40	21.5	16.8	15.1	12.4	9.1	6.0	3.9
	50	23.1	18.9	17.2	14.5	10.9	7.2	4.8
	100	24.9	24.1	23.1	20.9	17.2	12.4	8.7

**Figure 3-18.** Proportional power loss as a function of loudspeaker cable gauge and cable length.

### 3.4 SAnet Connections

SAnet uses a symmetrical, two-wire connection. The advantage of a symmetrical connection is that “common mode” interference (= external interference such as power-up peaks from other equipment, radio interference and interference from light dimmers) has less influence on the signal.

You are advised to use two-wire coaxial cable (known as “twinax”) as the connecting cable. If the system is not going to be used under extreme circumstances, well screened microphone cable may be sufficient. The maximum cable length is approximately 500 m when using twinax and 250 m when using screened microphone cable.

The required connector is of the 4-pole XLR type, such as the Neutrik NC-4-FC (female) or NC-4-FRC (female / angled) and the NC-4-MC (male) or NC-4-MRC (male / angled). These connectors are mechanically very robust, currently popular and readily available at your local suppliers.

The XLR connectors (SAnet in and SAnet out) of the PPA are wired as follows:

- Pin 1 = ground (screening)
- Pin 2 = +5 V for future use of remote control
- Pin 3 = SAnet in phase (+ or “hot”)
- Pin 4 = SAnet out phase ( - or “cold”)

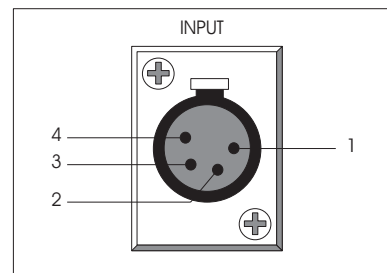

Using the output connector, a maximum of 250 units (PPAs and/or other equipment with an SAnet interface) can be linked to SAnet.

SAnet and other communication systems such as MIDI are NOT compatible. Therefore, never make a connection between SAnet and MIDI equipment. If you do, it can result in damage to your equipment.

For the sake of clarity: ALL PPAs that are part of a sound system can be connected with each other via SAnet, without differentiation between “left” and “right” in a stereo set-up. SAnet is a communication network that is separate from the audio signal route and therefore has no influence on the sound and/or stereo image.

## 4 Operation

After connection to the correct mains voltage, the PPA 1200 is switched on using the <POWER> switch. The first time, or after for example the software has been updated, both channels will start up in <STAND BY> mode.

The various functions of the system will now be described one after one. It is advisable to practise the various functions and operations described in this manual with a PPA.

### 4.1 Readout Select

This key is used to make a choice from six different readouts:

- Input sensitivity of the amplifiers in dB <LEVEL>
- Temperature of the power amplifiers in °C <TEMPERATURE>
- Average power delivered in Watts<AVERAGE POWER>
- Peak power delivered in Watts<PEAK POWER>
- Maximum average power delivered in Watts <MAXIMUM POWER>
- Power amplifier on delay in seconds<POWER AMP ON DELAY>

### 4.2 Level

When you touch an <UP/DOWN> key, and the <READOUT SELECT> is not equal to <MAXIMUM POWER> or <POWER AMP ON DELAY>, the display automatically jumps to <LEVEL>. The range of <LEVEL> is from OFF, via -59 dB to 0 dBm, in steps of 1 dB. If you keep an <UP> or <DOWN> key depressed, the level increases or decreases respectively with increasing speed.

If you depress both <UP/DOWN> keys simultaneously, the level of the concerned amplifier is set to <OFF>. However, in active crossover mode (see next paragraph), the level of both amplifiers is set to <OFF>. This works as an “emergency stop”.

NOTE: If you are free to choose the level (input attenuation), select 0 dB. In this way, the chance of overloading the input stage is minimal. The input accepts any level up to +20 dBu.

### 4.3 Maximum Power and Active Crossover Presets

When you select <MAXIMUM POWER> with the <READOUT SELECT> key, you may adjust the maximum delivered average output power at which the amplifier starts to reduce its output signal. This power can be adjusted between 30 Watts and 900 Watts in steps of 10 Watts using the <UP/DOWN> keys.



Both <UP/DOWN> keys may also be used to select an active crossover factory preset to form an active loudspeaker system. Select a maximum power equal to 30 Watts and keep the channel 1 or channel 2 <DOWN> key pressed to enter the active crossover factory preset selection. The built-in crossover has Bessel slopes. Besides the crossover, a built-in rumble filter with a cut-off frequency of 15 Hz and 24 dB/octave Bessel slope becomes active.

In case a factory preset is selected, the display will indicate which, e.g. PERF 2-26 for a performer 2-26 system. The following versions are available:

Type	Cabinet	X-over ch1 (Hz)	X-over ch2 (Hz)	Software version
Standard	M44, M47	15 - 1000	1000 - <sup>1)</sup>	V2.8
Master	M49	15 - 100 <sup>2)</sup>	15 - 100 <sup>2)</sup>	V10.8
Master	M49	15 - 1000	1000 <sup>3)</sup> - <sup>1)</sup>	V11.8
Champion	C14 <sup>4)</sup>	15 - 100 <sup>5)</sup>	15 - 100 <sup>5)</sup>	V14.8
Performer 24/26	P16	40 - 100	40 - 100	V16.0
Performer 27/29	P17	40 - 70	40 - 70	V17.0
Performer 24/26	P24 & P26	100 - 1000	1000 <sup>3)</sup> - 1	V18.0
Performer 27/29	P27 & P29	70 - 1000	1000 <sup>3)</sup> - 1	V19.0

Notes:

- 1) No low pass filter for the high frequency is installed
- 2) The 100 Hz low pass filter has 6 dB/octave slopes
- 3) 24 dB / octave Bessel filter including compensation for the Constant Directivity Horn.
- 4) This version is intended as sub-low in combination with the BB25 Blue Box
- 5) The 100 Hz low pass filter has 12 dB / octave Bessel slopes

As soon as the active crossover factory preset selection is entered, the channel mode of both amplifiers is reset to <STAND BY>. This is done to prevent damage to your loudspeaker system during selection. The active crossover factory preset selection can be left by pressing the channel 1 or channel 2 <UP> key until the channel 1 or channel 2 maximum power becomes 30 Watts or more.

NOTE: Once an active crossover factory preset has been selected, each time an <UP> or <DOWN> key is pressed, the displays sequentially show two indications: low/mid/high (LO/MI/HI) and level or active crossover factory preset name, depending on readout select. After power-up, all three indications are sequentially shown for 20 seconds.



#### 4.4 Power Amp On Delay

The automatic switching to <POWER AMP ON> mentioned earlier occurs after a programmable time delay. The aim of this function is to allow a number of PPAs to automatically switch to <POWER AMP ON> mode one after another with a time interval so that the mains supply is not overburdened. If a number of PPAs are switched on simultaneously without using the mains power switch (for example placing the plug in the socket or when power returns after a power failure) this feature prevents melting of the fuses, which would otherwise occur because of the high peak current.

The switch-on current of the high power supply of the PPA can be more than three times its nominal current. It is easy to imagine what will happen if, for example, four PPAs are switched on simultaneously. The <POWER ON DELAY> removes the need for switching (switching off and then again on) all the <POWER ON/OFF> switches of the PPAs after for example a power failure.

The <POWER AMP ON DELAY> is set as follows:

Select <POWER AMP ON DELAY> readout with the <READOUT SELECT> key. The default values for the delays of both amplifiers are respectively 2 and 4 seconds. Using the <UP/DOWN> keys, these values can be set between 2 and 100 seconds, in steps of 2 seconds. From "2" you can jump directly to "100" and lower values using the <DOWN> key.

**IMPORTANT:** To avoid overburdening the power supply ALWAYS adjust the two "power amp on" delays with a different value!

In a permanent installation, such as in a discotheque, etc., this feature makes it possible to centralize the power supply of the PPAs so that it is not required to switch each unit on and off individually.

#### 4.5 Channel Mode

Both amplifiers of the PPA start up in <STAND BY> mode the first time the PPA is used, with the green LEDs on. Using the <CHANNEL MODE> keys, both amplifiers may be switched on separately, whereby the red LED for <POWER AMP ON> comes on.

**IMPORTANT:** To avoid overburdening the power supply NEVER switch both amplifiers simultaneously on!

After switching the amplifier(s) on, the system waits five seconds before connecting the loudspeakers to the amplifier(s). Both amplifiers require this period to stabilize. Subsequently, the signal is gradually fed to the amplifier(s) using an automatic "fade in".

The amplifiers of the PPA start up automatically in the <POWER AMP ON> mode if they were switched off the previous time while in the <POWER AMP ON> mode. The system "remembers" the last mode. After switching the system on, the adjustable delay (variable from 2 to 100

seconds) is counted down. Subsequently, the amplifier(s) automatically switch(es) to <POWER AMP ON> mode. The signal is fed to the amplifier(s) five seconds after switching to the <POWER AMP ON> mode.

Even after a power failure, the PPA starts up in the way described above. The PPA is protected against power failures and fast switching on and off: It is not necessary to set the level of the amplifiers to “OFF” before switching the system off, as the system is protected against signal spikes. The adjustment of the power on delay is described in the previous paragraph.

**4.6 System Ground Lift**

If hum or another strange sound is audible after switching on an amplifier of the PPA, the cause may be incorrect earthing of your sound system. The <SYSTEM GROUND> key can be used to “lift” the connection between the system earth and the mains earth. This action alone is often

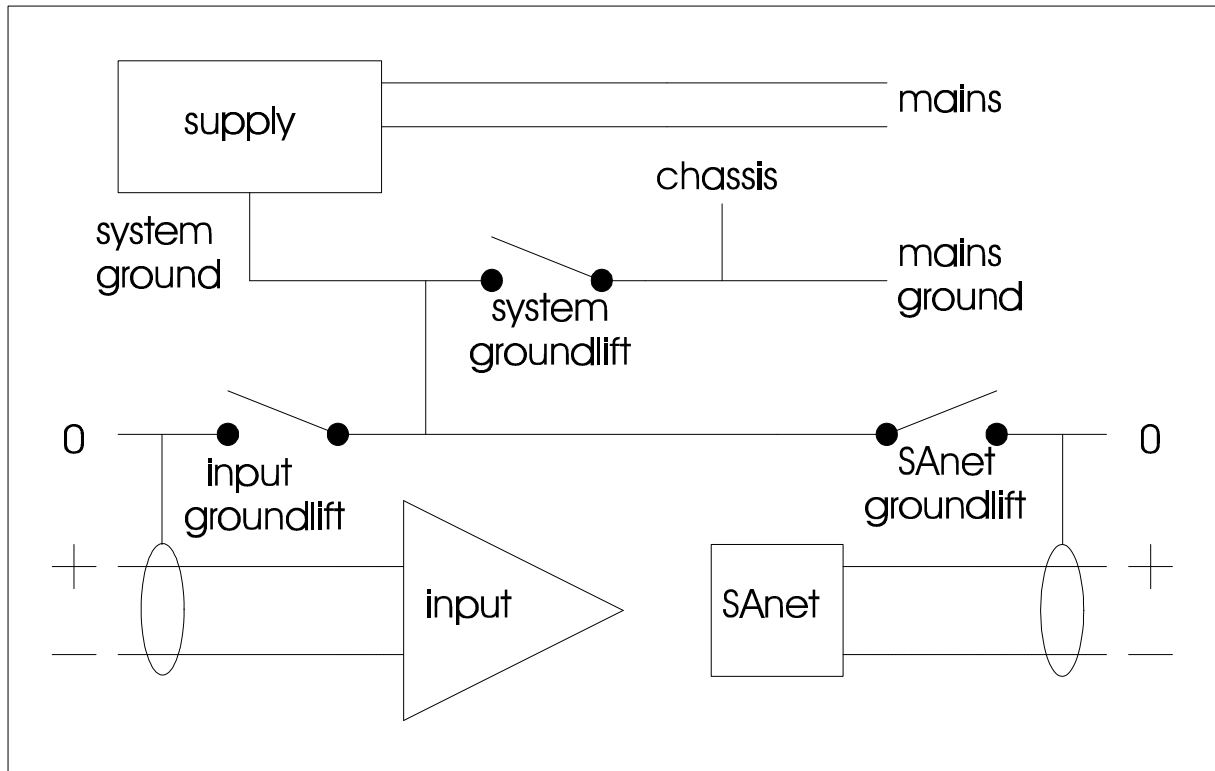

**Figure 4-1** The various ground connections of the PPA 1200.

sufficient to eliminate the undesired noise caused by a “dirty supply”. If you activate the <SYSTEM GROUND>, the yellow LED by <LIFTED> will light.

If the hum does not disappear after lifting, you should try to lift other grounds with the <SA-NET GROUND> key or <INPUT GROUND> keys (see next paragraphs), or search for the cause elsewhere in the sound system. In this case, systematically check all other components being





used, such as effect racks, mixing desk, etc. Moreover, to aid in preventing such interference it is advisable to keep signal cables well away from power cables and cables from, for example, lighting equipment. Figure 4-1 illustrates the various ground connections.

#### 4.7 SAnet Ground Lift

The connection between the incoming SAnet earth and the system earth can also be lifted using the <SA-NET GROUND> key. In this case, the yellow LED by <LIFTED> will light.

#### 4.8 Input Ground Lift

The connection between the incoming signal earths and the system earth can also be lifted using the <INPUT GROUND> keys. In this case, the yellow LEDs by <LIFTED> will light.

#### 4.9 System Lock/Unlock

To prevent unauthorized or undesired changes to system settings, the PPA is provided with a <SYSTEM LOCK> facility in the form of a 3-digit "lock code".

##### System Lock

To "lock" the system, do as follows:

Press the <SYSTEM LOCK> key until an initiated lock code with a value of "1" appears in the channel 1 display. The desired numeric code can now be programmed using the channel 1 <UP/DOWN> keys. Any value between "1" and "999" can be selected. From "1" you can jump directly to "999" and lower numbers using the <DOWN> key.

Now, press the <SYSTEM LOCK> key again: the PPA is now locked. No parameters can be changed. It is, however, possible to call up various readings in the displays using the <READ-OUT SELECT> key.

##### Unlock

To "unlock" the PPA, proceed as follows:

Press the <SYSTEM LOCK> key until an initiated unlock code with a value of "1" appears in the channel 1 display.

Now, use the <UP/DOWN> keys to set the correct unlock code (i.e. the value entered previously in the "locking" procedure). From "1" you can jump directly to "999" and lower numbers using the <DOWN> key. After setting the correct value, press the <SYSTEM LOCK> key again: the PPA is now unlocked.

If an incorrect unlock code is entered, the PPA remains locked and the figure "1" will appear in the display again, indicating that your entry was incorrect. The unlocking procedure can then be repeated.



## Resetting the System Lock and Lock Code

This confidential information is given in paragraph 8-1, which may be omitted from this manual for safety reasons.

### 4.10 Bridge Mode

The PPA can be internally set for bridge mode operation by pressing the <BRIDGE MODE> switch for at least 1 second. In bridge mode, the yellow LED by <ON> will light and all functions are controlled by the channel 1 keys and display.

After bridge mode has been selected on or off, both amplifiers of the PPA are set <STAND BY> because the output wiring might have to be changed (see paragraph 3-3).

### 4.11 Software Version

As a result of Stage Accompany's policy of continuous development and improvement, the software of the PPA is regularly updated. To check which software version your PPA is provided with, act as follows:

#### Reading the software version

Press the <READOUT SELECT> key and keep it depressed. Next press the channel 1 <DOWN> key for at least 1 second. The software version installed in your PPA appears in the channel 2 display, for example 2.4 (see figure 4-2). Press the <READOUT SELECT> key to return to normal readout mode.

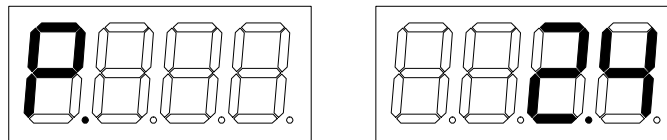

Figure 4-2 PPA 1200 software version readout example.

### 4.12 ID Code

Each PPA has its own, unique identity code. This code is important when using a PPA in combination with a Personal Computer, because the computer "recognizes" the PPA by its ID code.

However, the ID code is also very important for you. After hiring out or lending a PPA, you can check whether the PPA returned is the correct one. Furthermore, the unique ID code, in addition to the "lock" function, provides extra protection against theft.

If you note the ID codes of your PPAs and report them to Stage Accompany in the event of theft, the ID codes concerned will be circulated worldwide throughout the Stage Accompany dealer network. This prevents trading of stolen PPAs since the ID code cannot be changed.

## Reading the ID Code

Press the <READOUT SELECT> key and keep it depressed. Next press the channel 1 <UP> key for at least 1 second. The ID code of your PPA appears in the channel 2 display, for example 123 (see figure 4-3). Press the <READOUT SELECT> key to return to normal readout mode.

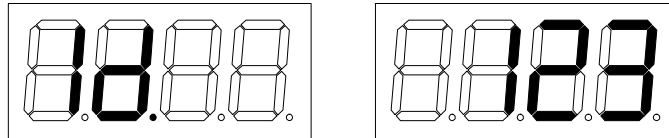

Figure 4-3. PPA 1200 ID code readout example.

## 4.13 Signal Present Time

The “signal present” time of the PPA is defined as the time during which the input signal level of either channel has been greater than -40 dBu. This “signal present” time (in hours) has been reset off factory and can afterwards only be reset by a Stage Accompany dealer via the SAnet interface.

### Reading the Signal Present Time

Press the <READOUT SELECT> key and keep it depressed. Next press the channel 2 <DOWN> key for at least 1 second. The “signal present” time (in hours) of your PPA appears in the channel 2 display, for example 456 (see figure 4-4 on the next page). Press the <READOUT SELECT> key to return to normal readout mode.

NOTE: The separate “signal present” times per channel can be read out following the above procedure with the corresponding <INPUT GROUND> key in stead of the channel 2 <DOWN> key.

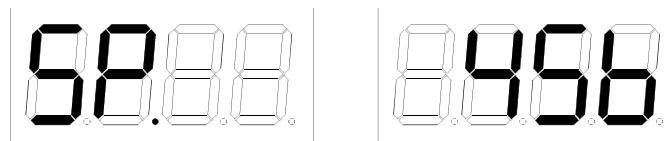

Figure 4-4 PPA 1200 signal present time readout example.

#### 4.14 Power Amplifier On Time

The “power amplifier on” time of the PPA 1200 is defined as the time during which at least one of the power amplifiers has been in <POWER AMP ON> mode. This “power amplifier on” time (in hours) has been reset off factory and can afterwards only be reset by a Stage Accompany dealer via the SAnet interface.

##### Reading the Amplifier On Time

Press the <READOUT SELECT> key and keep it depressed. Next press the <SA-NET GROUND> key for at least 1 second. The “power amplifier on” time (in hours) of your PPA appears in the channel 2 display, for example 789 (see figure 4-5). Press the <READOUT SELECT> key to return to normal readout mode.

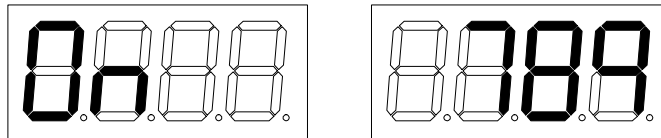

Figure 4-6 PPA 1200 power amplifier on time readout example.

#### 4.15 Activating the “boot” mode

The PPA is provided with an electrically reprogrammable software memory. As a result, it is possible to update the software via SAnet, without having to open the casing.

To provide the PPA with new software, the so-called “BOOT” mode has to be activated. The Stage Accompany PC-AT or any IBM (compatible) PC-AT can then be used to update the software via SAnet. To activate the “BOOT” mode, press both <SYSTEM GROUND> key and <SA-NET GROUND> key while switching on the PPA until the displays show (see next page):

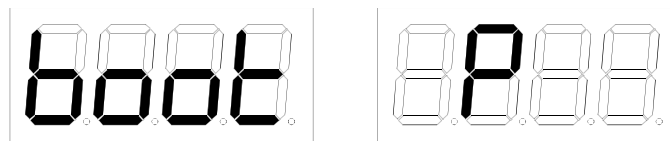

Figure 4-5 PPA 1200 boot mode readout.

The running <READOUT SELECT> LEDs indicate that the “BOOT” mode is active. The “P” in the channel 2 display shows that the PPA already has software installed (“P” from Programmed). If the software memory is empty or defective, the display will show “E” (“E” from Empty). Contact your dealer for more information about updating the PPA via SAnet using the Stage Accompany PC-AT or any IBM (compatible) PC-AT.



**PPA 1200 USER MANUAL**

**OPERATION**



*The Professionals  
For Professionals !*



## 5 Indicators

A number of indicators per channel are provided on the front of the PPA which can be divided into LED indications and display messages.

LED indicators:	Indication:
• Input signal present indicator	<SIGNAL PRESENT>
• Clipping of the amplifier	<CLIP>
• Power limiting	<POWER LIMIT>

Display indicators:	Message:
• DC protection of the amplifier	< dc >
• Overheated amplifier	<HEAT>
• High power fuse blown	<FUSE>

### Explanation of the LED indicators

#### 5.1 Input Signal Present

The <SIGNAL PRESENT> indicator is active whenever a signal greater than -40 dBu is present at the input stage.

#### 5.2 Clipping of the Amplifier

The <CLIP> indicator is active for at least 0.3 seconds if the output voltage of the amplifier clips against the supply voltage.

#### 5.3 Power Limiting

The input signal for the amplifiers is reduced by the processor so that the peak and average power delivered to the loudspeaker do not exceed a preprogrammed, save limit. The maximum peak power has been factory set while the average maximum power may be adjusted by the user through the <MAXIMUM POWER> function (see paragraph 4-3). Large signal peaks can be withstood by a loudspeaker and are transmitted without hindrance. Thus the signal remains “fast”, “tight” and “transparent”.

The protection needs to react quickly in unexpected situations, for example in case of feedback. However, this is not a 100% guarantee that the speaker cannot be damaged! It is therefore important that the system is not used for too long at <POWER LIMIT> conditions: the activation of the <POWER LIMIT> protection indicates a serious degree of overload.



## Explanation of the display messages

### 5.4 DC Protection of the Amplifier

The < dc > message is shown in the display whenever a direct current that would be dangerous for the loudspeaker is present at the output of the amplifier. The DC protection disconnects the loudspeaker from the amplifier, while the signal to the amplifier is switched off. After five seconds, provided that the direct current has disappeared, the signal is supplied again and the connection to the loudspeaker is reactivated. In case of permanent DC, examination and repair by an official Stage Accompany dealer is necessary.

### 5.5 Overheated Amplifier

The fan is switched to high speed whenever the temperature of one of the amplifiers reaches more than 50 degrees Celcius (50 °C). The fan is switched to low speed again after the temperature has dropped below 45 °C.

The <HEAT> message is alternately shown with the temperature in the display whenever the temperature of the amplifier reaches more than 85 degrees Celsius (85 °C). The processor switches the signal of the amplifier off at this temperature, allowing the output devices to cool down. The signal is switched on again after the temperature has dropped below 80 °C.

If, after switching off the signal, the temperature continues to increase, the high power supply is switched off after a temperature of more than 90 °C has been reached. The power supply is switched on again after the temperature has dropped below 80 °C.

### 5.6 High Power Fuse Blown

The <FUSE> message is shown in the display whenever the high power fuse of the corresponding amplifier at the rear of the PPA has blown.

**WARNING:** Always disconnect the PPA from the power supply before operating on the fuse holders! Replace a blown fuse only with a new one of the same value!





## 6 Recommendations for Optimum Use

- Ensure that the mains supply is of a good enough quality and that it can supply the required peak current values. In addition, a good earthing is necessary to prevent noise, hum and safety problems. If hum does occur, it can almost always be cured using the ground lift keys.
- All programmed settings of a PPA are automatically saved in memory. Therefore, any changes you may make do not have to be saved separately. When a PPA is switched on (after first use), all parameters will be adjusted to the last programmed values. As a result, PPAs used as part of a fixed set-up only need to be programmed once.
- NOTE: After a software update all settings are erased and the PPA concerned has to be reprogrammed.
- Be sure that the PPA is built into a space with sufficient circulation of fresh air. A temperature that is constantly too high leads to switching on and off of the protection and considerably reduces the lifetime of the amplifier.
- As noted earlier, the <POWER LIMIT> function is a sort of emergency measure. Considering that the processor is much faster than the user, the system can react appropriately and quickly to unexpected situations. It is recommended that you trace the source of overload and remedy it as soon as possible. Just to reiterate: the <POWER LIMIT> function does not offer a 100% guarantee against damaging the loudspeakers. It is, however, an excellent aid in preventing problems such as distortion.
- The excellent sound quality of the PPA greatly depends on the correct adjustment of the various system parameters. You are therefore advised to “lock” the PPA as soon as possible after setting the desired parameters so that it cannot be interfered with by unauthorized personnel. Of course, it is just as important that you remember the “lock code” you entered.
- A faulty fuse must ALWAYS be replaced with a new one of the same value. A fuse of a different value can cause permanent damage to the microcomputer. Always disconnect the PPA from the power supply before operating on the fuse holders!
- Repairs to the PPA should only be carried out by an authorized Stage Accompany dealer. Never dismantle the PPA yourself, because you risk damaging vital components: moreover, the guarantee becomes irrevocably invalidated.
- Read this manual carefully. As you go, try out the various functions described in this manual: in this way you will soon become familiar with the many possibilities that the PPA offers.
- It is just as important that your colleagues who will use the PPA also read the manual!



- With a good knowledge of the working of the PPA, it is possible to fully utilize its superior sound quality in every situation.

**SUCCESS!**

RECOMMENDATIONS



*The Professionals  
For Professionals !*



## 7 PPA 1200 Specifications

Input:	+6 dBm (reference 0 dBm = 0.775 V) (full output in 4 Ohms)
Maximum input level:	+20 dBm
Input impedance:	24 kOhms each leg (30 kOhms unbalanced)
Common mode suppression:	70 dB @ 1 kHz 65 dB @ 20 kHz
Frequency range:	20 Hz - 20 kHz; 0.3 dB @ 300 W into 8 Ohms 5 Hz - 80 kHz; -3 dB @ 300 W into 8 Ohms
Gain:	32 (30 dB)
Channel separation:	80 dB @ 1 kHz, 300 W into 8 Ohms 60 dB @ 20 kHz, 300 W into 8 Ohms
Two-way crossover point:	1 kHz, 24 dB/oct., Bessel
Total harmonic distortion (THD):	< 0.08% @ 20 Hz to 20 kHz, load > 2 Ohms, at all powers 10% below clip level < 0.008% @ 1 kHz, 200 W into 8 Ohms < 0.015% @ 20 kHz, 200 W into 8 Ohms < 0.008% @ 1 kHz, 1 W into 8 Ohms
Intermodulation distortion (IMD):	< 0.01% @ 200 Hz to 20 kHz with F1 = 70 Hz, 4:1, 200 W into 8 Ohms
Signal/noise ratio:	110 dB
Slew rate:	40 V/us
Damping (with DDC):	10,000, @ 1 kHz, 10 V into 8 Ohms
Power delivered:	2 x 180 W RMS into 16 Ohms 2 x 350 W RMS into 8 Ohms 2 x 600 W RMS into 4 Ohms 2 x 900 W RMS into 2 Ohms



# PPA 1200 USER MANUAL

Bridge mode power delivered:	1 x 700 W RMS into 16 Ohms 1 x 1200 W RMS into 8 Ohms 1 x 1800 W RMS into 4 Ohms
Mains supply voltage:	Stated at rear of amplifier
Continuous power consumption:	Standby: 100 W, max. output: 3520 W
Weight:	33.7 kg
Housing:	19 inch rack mount, 4 units high, 17.3 inch deep (without connectors)
Dimensions (h x w x d, mm):	178 x 482 x 442 (without connectors)

SPECIFICATIONS



**PPA 1200 USER MANUAL**

**SPECIFICATIONS**



*The Professionals  
For Professionals !*



## 8 Security Function

This chapter contains the information of one security function. You may remove this chapter from the manual for safety reasons.

### 8.1 Resetting the System Lock and Lock Code

This function allows you to unlock the PPA 1200 in case you have forgotten the lock code. To do this depress the <SA-NET GROUND> key while switching on the PPA. The PPA will then be unlocked and the locking code set to 1.

# PPA 1200. Programmable Power Amplifier.

## FRONT VIEW

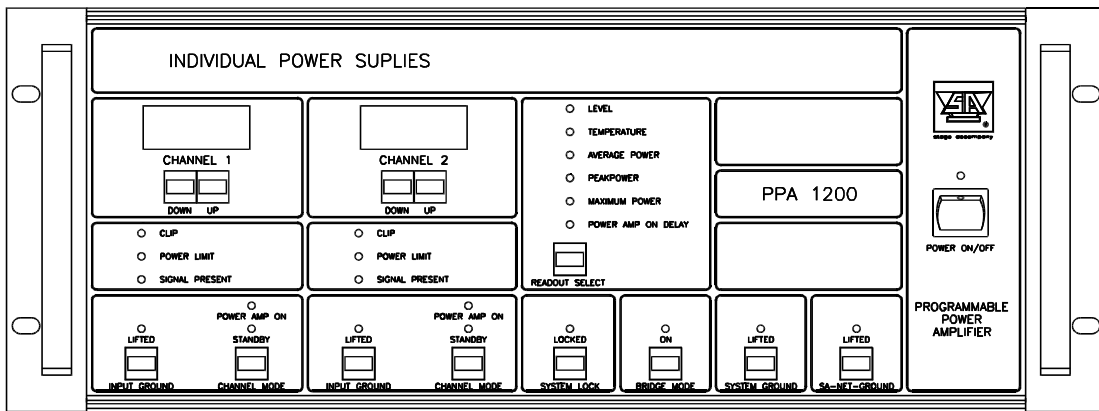

## REAR VIEW

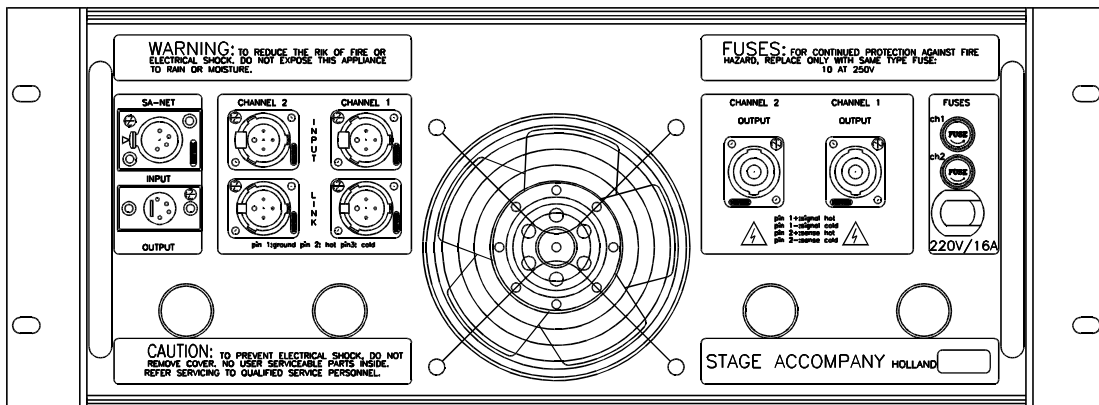

## Trouble Shooting

